

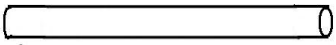

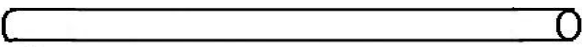

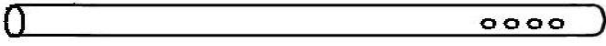

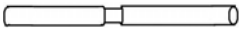





5 x 10 m PVC STYK LISTE

Artikel-nummer		Beskrivelse	Antal
1		Galvaniseret rør diameter 38mm 550mm	12
2		Galvaniseret rør diameter 38mm 1940mm	27
4		Galvaniseret rør diameter 38mm 1920mm	12
5		2-vejs samling	12
6		3-vejs samling	4
7		4-vejs samling	8
8		3-vejs samling	2
9		4-vejs samling	4
10		Fod	12
11		Jordanker	4
12		Jordspyd	12
13		Jordspyd	48
14		Elastik	22
15		Elastik	124
16		Teltline	4
17		Skrue	90
18		Tagdug	1
19		Gavl	2
20		Sidevæg	10

I Monter alle rør og samlinger som vist på billedet.

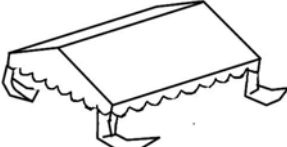
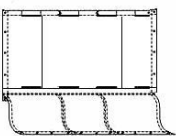
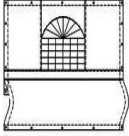
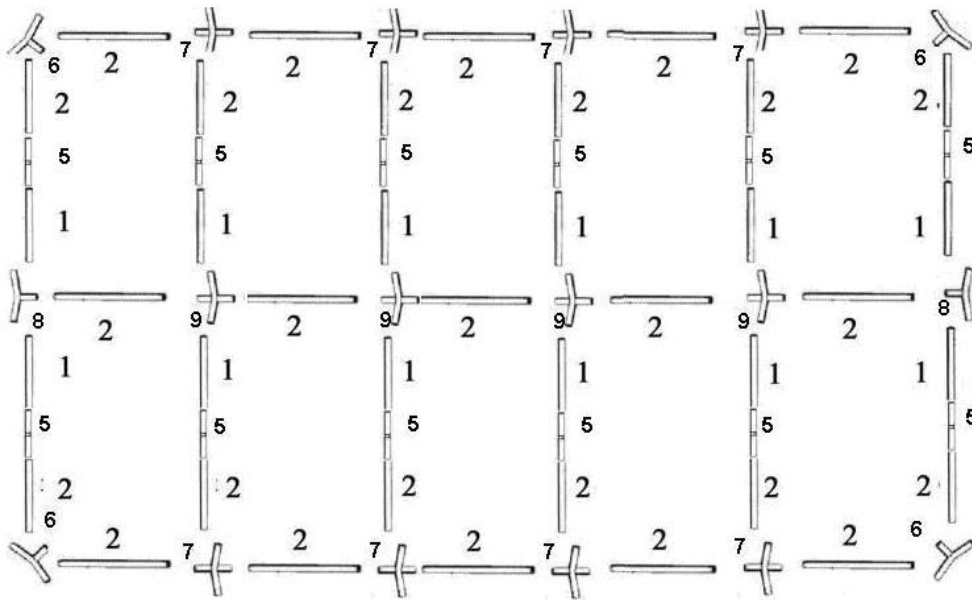

II Løft den ene side og monter rør nr. 4.

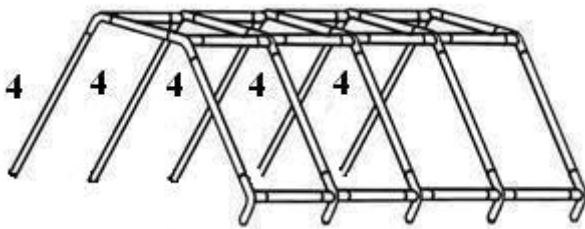

III Læg tagdugen ud over stellet.

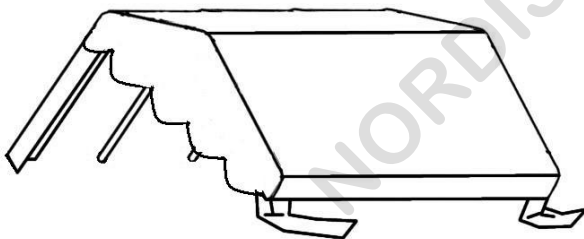

IV Anvend elastikkerne til at fastmontere tagdugen til stellet.

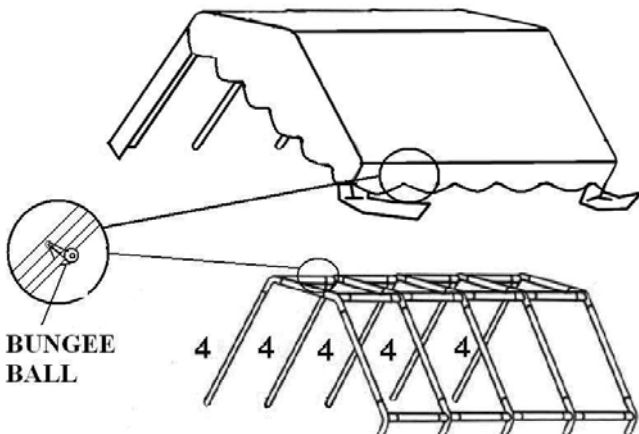

V Løft modsatte side. Monter fødderne.

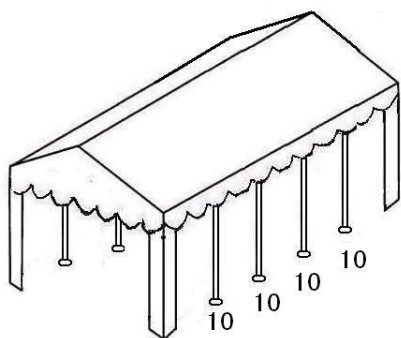

VI Monter sidevægge og gavle. Anvend elastikker for at gøre disse fast til stellet.

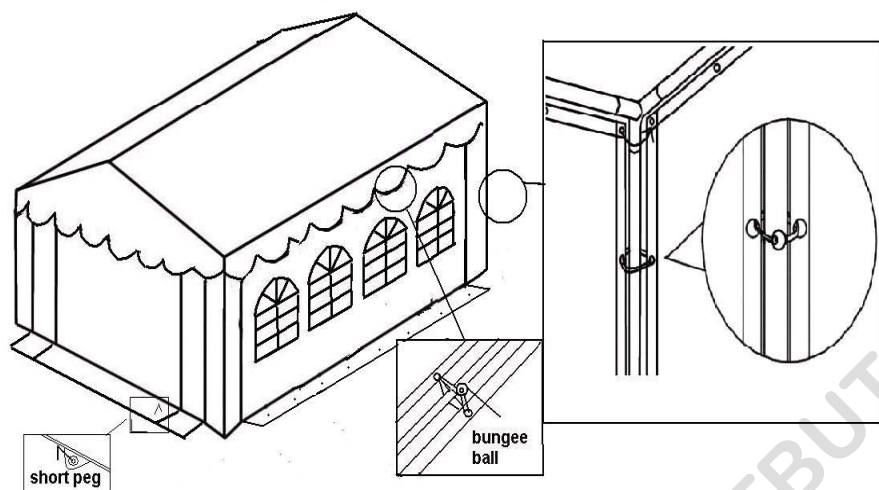

VII Anvend jordspyd og teltline for at øge teltets stabilitet.

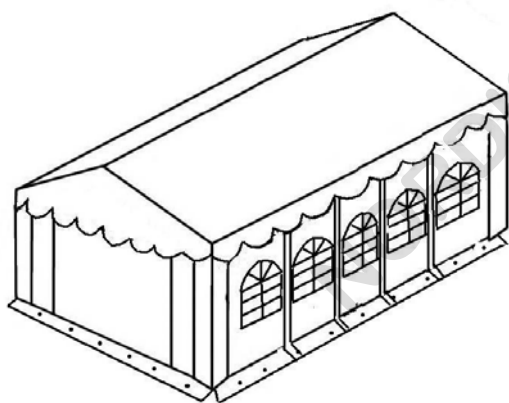



Vigtigt

1. Vær forsigtig med delene under opsætning og nedtagning. Ellers kan de blive beskadiget.
2. Teltet er ikke konstrueret til at stå opsat i længere perioder. Hvis det bliver hårdt vejr skal det nedmonteres.
3. Find en egnet plads til teltet. Undgå sprinkler anlæg og kabler i jorden.
4. Selvom dette produkt er flamme hæmmende skal man være forsigtig. Hold åben ild og andre varme kilder væk fra teltet.

Billederne der er brugt i denne manual er kun til illustration, og kan afvige fra den købte model.

5 x 10 m BUNDRAMME

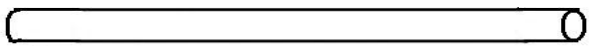
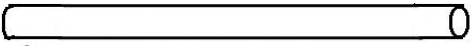
1. Følg samlevejledningen for teltet.
2. Monter fødderne (12&13) på benene (3) (Fig.4), i stedet for standard fødderne (NO.10) som følger med teltet. Anvend bolte for at fastgøre dem.
3. Når fødderne er monteret kan bundrammen monteres (1&2) på fødderne. (12.14.13)
4. Sæt sidevægge og gavle fast til bundrammen med elastikker.

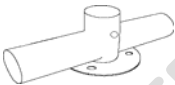
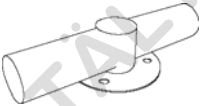
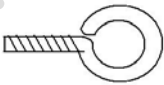
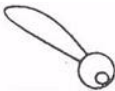
NO.1 X 10		Bundramme 1940mm
NO.2 X 6		Bundramme 1600mm
NO.12X 4		Fod hjørne
NO.13X 8		Fod sidevæg
NO.14X 4		Fod gavl
BT X 44		Bolt
BGX 36		Elastik

