

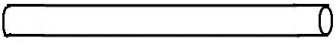

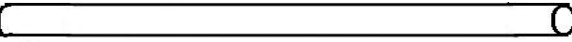

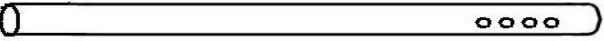

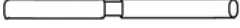





5 x 8 m PVC STYK LISTE

Artikel-nummer		Beskrivelse	Antal
1		Galvaniseret rør Diameter 38mm 550mm	10
2		Galvaniseret rør diameter 38mm 1940mm	22
4		Galvaniseret rør diameter 38mm 1920mm	10
5		2-vejs samling	10
6		3-vejs samling	4
7		4-vejs samling	6
8		3-vejs samling	2
9		4-vejs samling	3
10		Fod	10
11		Jordanker	4
12		Jordspyd	10
13		Jordspyd	42
14		Elastik	22
15		Elastik	106
16		Teltline	4
17		Skrue	74
18		Tagdug	1
19		Gavl	2
20		Sidevæg	8

I Sæt alle rør og samlinger sammen som vist på billedet.

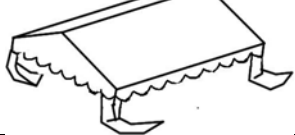
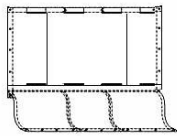
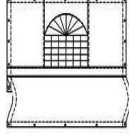
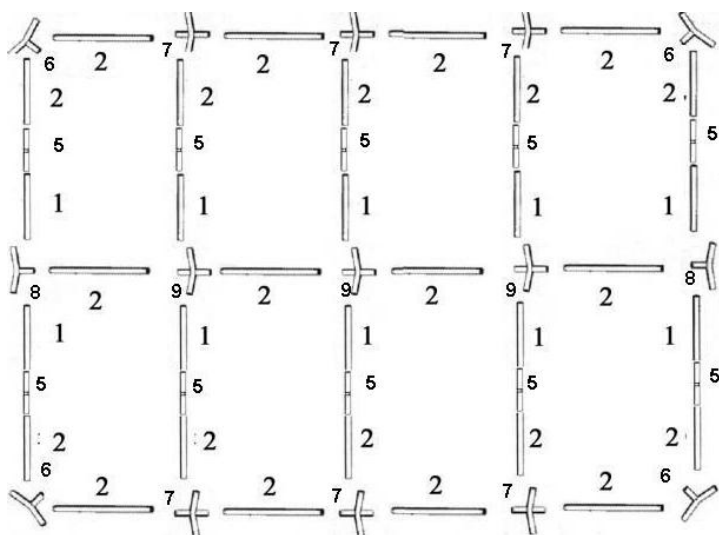

II Løft den ene side og monter rør nr. 4.

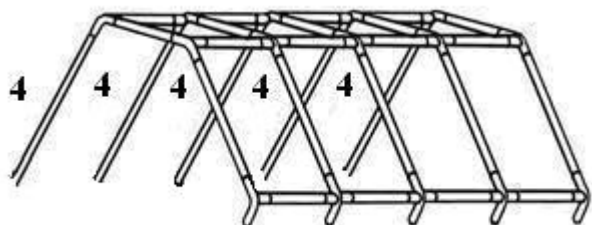

III Bred tagdugen ud over stellet.

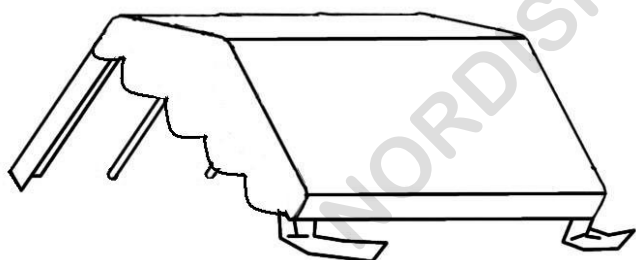

IV Anvend elastikker for at fastmontere tagdugen på stellet.

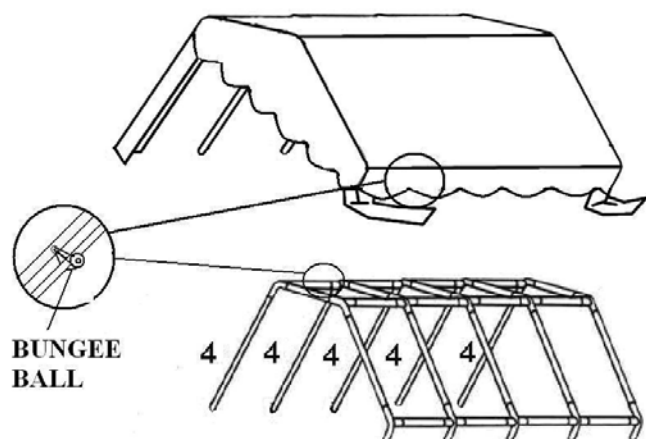

V Løft modsatte side. Monter fødderne.

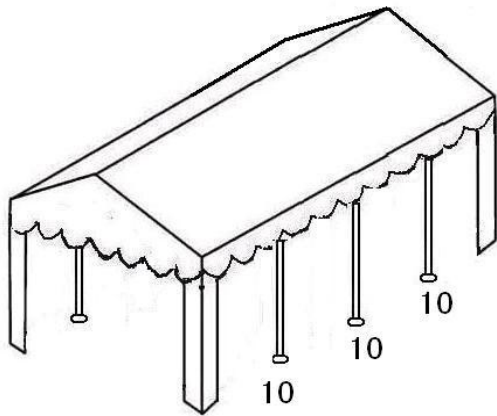

VI Monter sidevægge og gavle. Anvend elastikker.

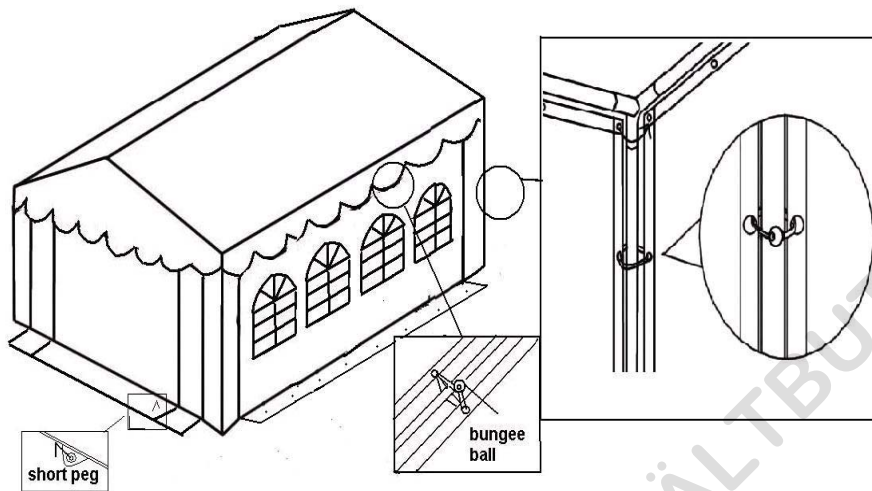

VII Anvend jordspyd og teltliner, til at gøre teltet mere stabilt.

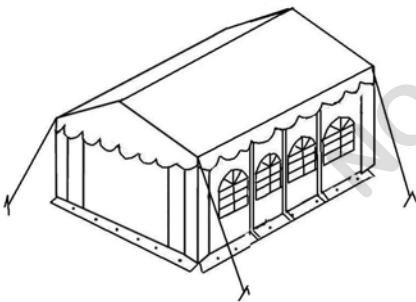





Vigtigt

1. Vær forsigtig med delene under opsætning og nedtagning. Ellers kan de blive beskadiget.
2. Teltet er ikke konstrueret til at stå opsat i længere perioder. Hvis det bliver hårdt vejr skal det nedmonteres.
3. Find en egnet plads til teltet. Undgå sprinkler anlæg og kabler i jorden.
4. Selvom dette produkt er flamme hæmmende skal man være forsigtig. Hold åben ild og andre varme kilder væk fra teltet.

Billederne der er brugt i denne manual er kun til illustration, og kan afvige fra den købte model.

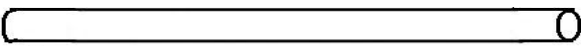
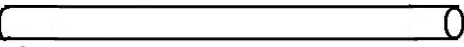
5 x 8 m BUNDRAMME

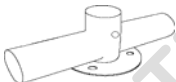
1. Følg samlevejledningen for teltet.
2. Monter fødderne (12&13) på benene (3) (Fig.4), i stedet for standard fødderne som følger med teltet. Anvend bolte for at fastgøre dem.
3. Når fødderne er monteret kan bundrammen monteres (1&2) på fødderne. (12.14.13)
4. Sæt sidevægge og gavle fast til bundrammen med elastikker.

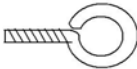
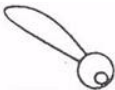
NO.1 X 8		Bundramme 1940mm
NO.2 X 6		Bundramme 1600mm
NO.12X 4		Fod hjørne
NO.13X 6		Fod sidevæg
NO.14X 4		Fod gavl
BT X 38		Bolt
BGX 36		Elastik

