

6 x 12 m PVC STYK LISTE

#1: 1470mm Galvaniseret rør

Antal 28



#2: 1940mm Galvaniseret rør

Antal 48



#3: 1920mm Galvaniseret rør

Antal 14



#4: 1500mm Galvaniseret rør

Antal 14

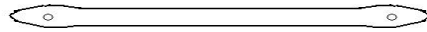

#5: 510mm Galvaniseret rør

Antal 7



#6: 110° 3-vejs samling

Antal 4



#7: 110° 4-vejs samling

Antal 10

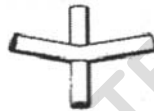

#8: 140° 3-vejs samling

Antal 2

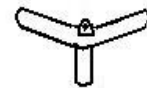

#9: 140° 4-vejs samling

Antal 5

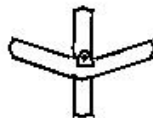

#10: Kryds 4-vejs

Antal 10

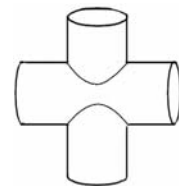

#11: 3-vejs samling

Antal 4

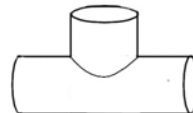

#12: 3-vejs samling

Antal 4

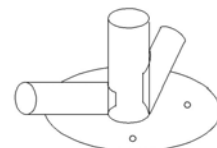

NORDISK TÅLTBUTIK AB

#13: 3-vejs samling

Antal 10

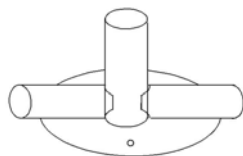

#14: 3-vejs samling

Antal 4

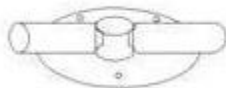

Tagdug

Antal 1

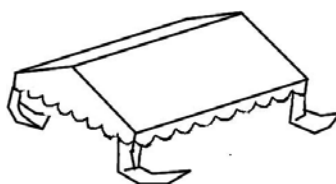

Sidevæg

Antal 12

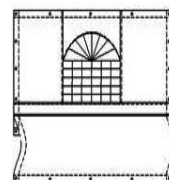

Gavl

Antal 2

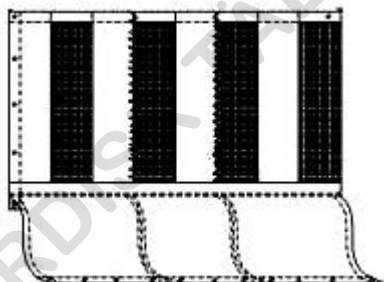

MONTERINGSVEJLEDNING

1. Placer alle samlinger, 1470mm rør og 1940mm rør på jorden som vist på billedet.

Anvend skruerne til at spænde delene sammen.

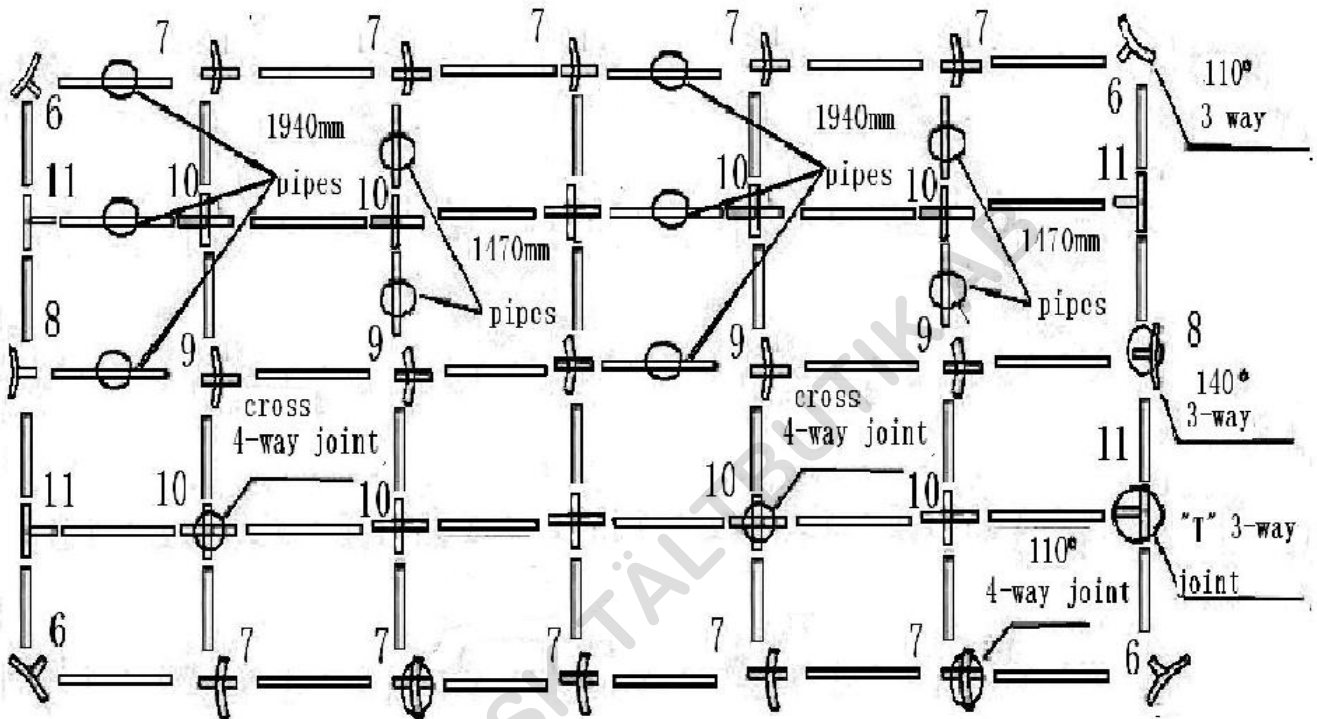

2. Sæt rørene sammen, begynd med de tre midterste rækker. Monter rør 4 og 5.

Sæt herefter de to sidste rækker på.

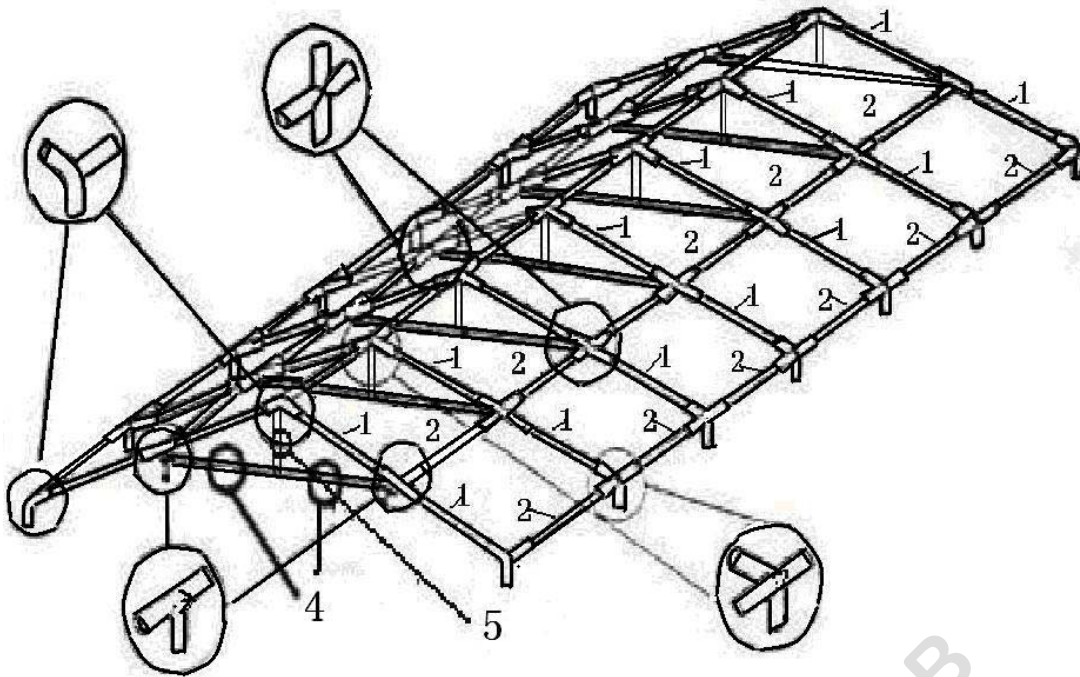

3. Læg tagdugen løst ud over stellet.
4. Monter ben på den ene langside.
5. Monter ben på den anden langside. Monter elastikkerne for at fastgøre tagdugen til stellet.
6. Monter bundrammen.
7. Monter sidevægge og gavle.

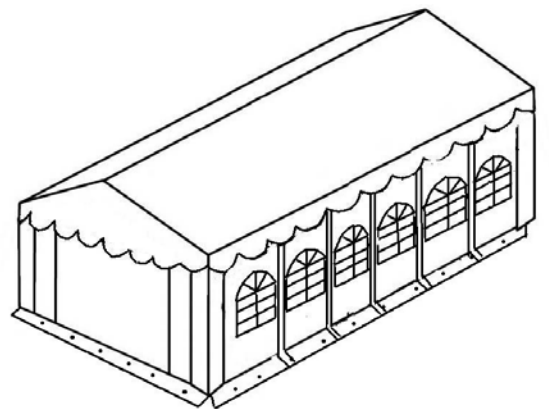
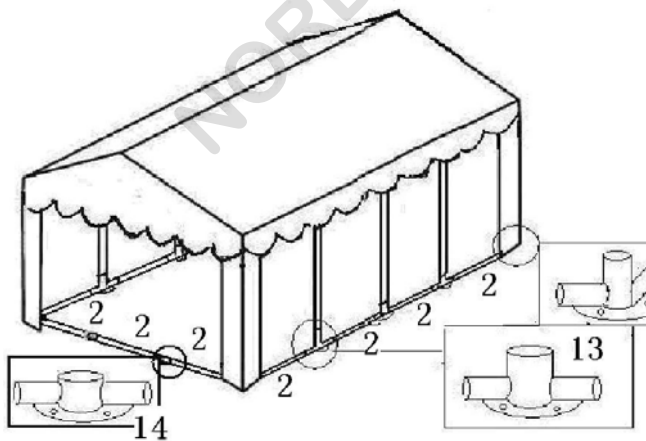

Vigtigt!

Anvend spændebånd og jordspyd hvis ekstra forankring er nødvendig.