

























PARTYTELT PVC 6x8, 6x10, 6x12

Artikel		Beskrivelse	Antal	Antal	Antal
		Størrelse	6x8m	6x10m	6x12m
1		Galvaniseret rør Diameter: 38mm Længde: 1470mm	20	24	28
2		Galvaniseret rør Diameter: 38mm Længde: 1940mm	34	41	48
3		Galvaniseret rør Diameter: 38mm Længde: 1920mm	10	12	14
4		Galvaniseret rør Diameter: 25mm Længde: 1500mm	10	12	14
5		Galvaniseret rør Diameter: 25mm Længde: 510mm	5	6	7
6		3-vejs samling	4	4	4
7		4-vejs samling	6	8	10
8		3-vejs samling	2	2	2
9		4-vejs samling	3	4	5
10		4-vejs samling	6	8	10
11		3-vejs samling	4	4	4
12		Fod	4	4	4
13		Fod	6	8	10
14		Fod	4	4	4
15		Jordanker	4	4	4

16		Pløk, lang	10	12	14
17		Pløk, kort	42	48	54
18		Elastiskstrop, kort	26	26	26
19		Elastiskstrop, lang	132	152	172
20		Teltline	4	4	4
21		Skrue	152	182	212
22		Møtrik	20	24	28
23		Tagdug	1	1	1
24		Gavl	2	2	2
25		Sidevæg	8	10	12

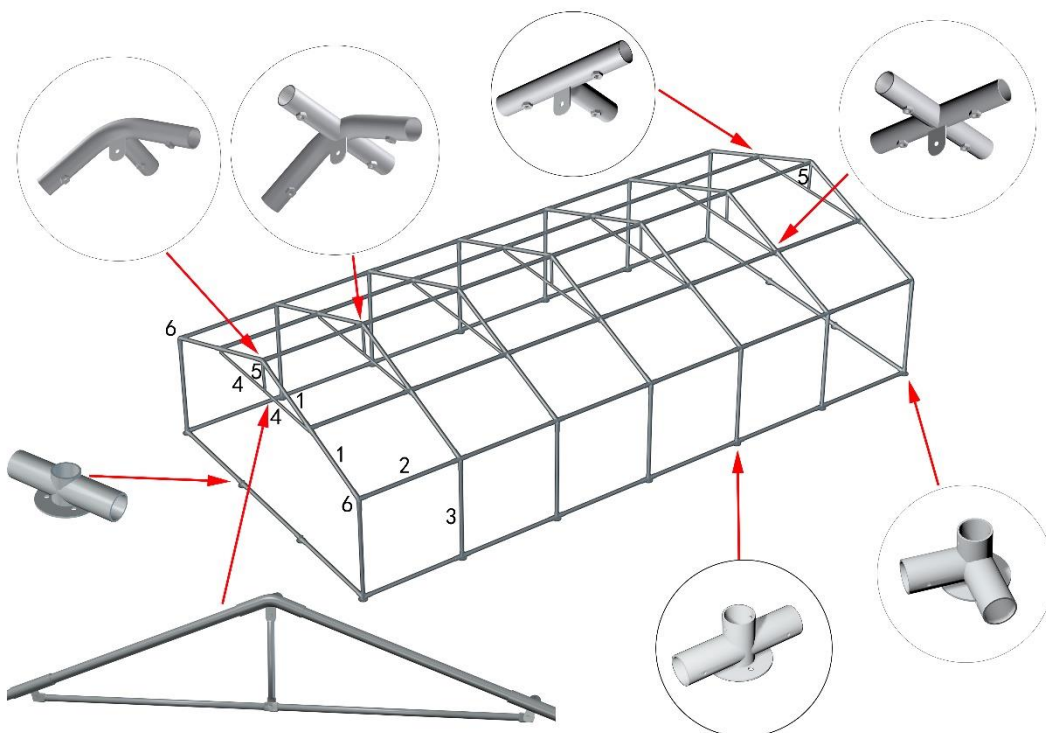

1. Læg alle samlinger (6,7,8,9,10,11) og rør (1, 2) på jorden som på billedet nedenfor.

Hvis det behøves kan rørene tørres af inden montering.

Anvend skrue (21) til at fastgøre dem.

- 2.** Monter rør og samlinger. Start med de tre midterste åse.

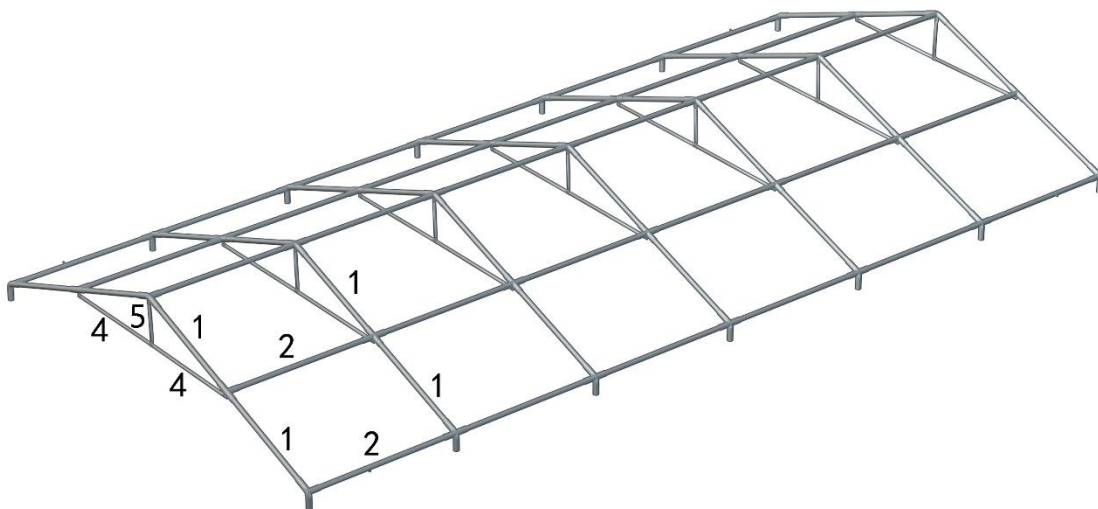
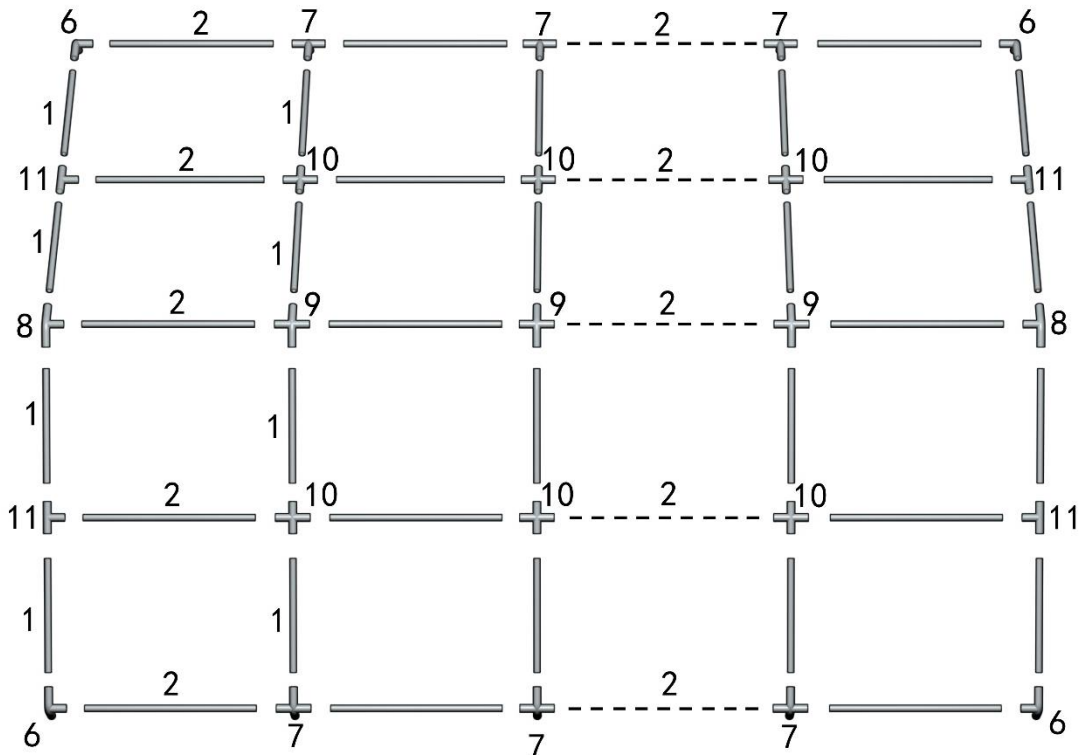

- 3.** Monter rør 4 og 5, med skrue (21) og møtrik (22).

4. Monter herefter de to yderste rækker med åse.

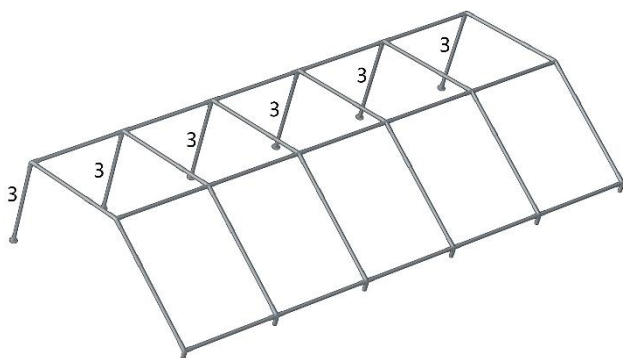
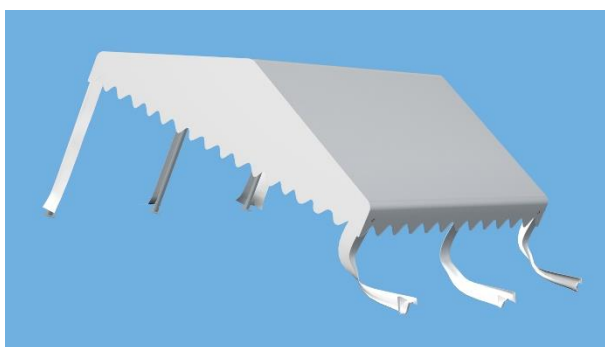
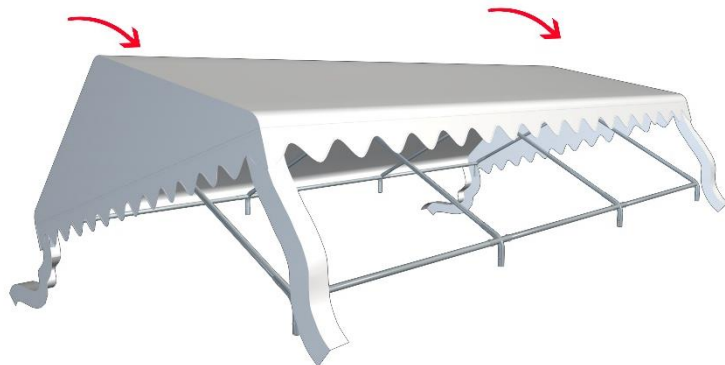

5. Læg tagdugen på

6. Monter ben (3) på den ene langside.

7. Løft den anden langside op og monter resterende rør nr. 3. Spænd tagdugen fast med elastikstropperne (19).

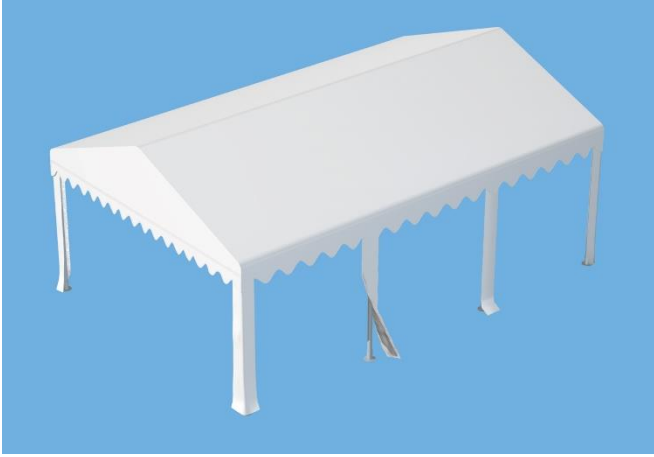

8. Monter bundrammen som vist på illustrationen nedenfor. Fod (12,13,14) og rør (2).

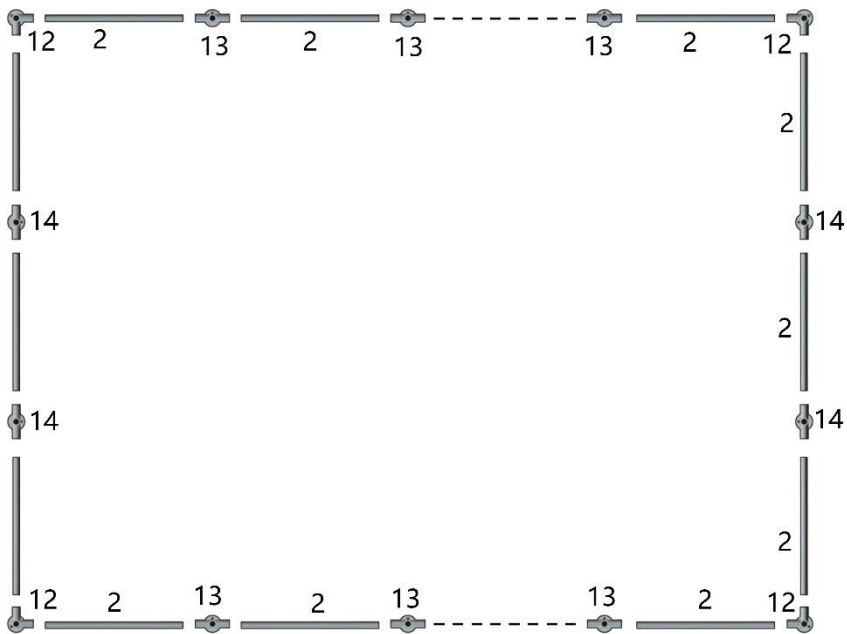

9. Sæt alle sidevægge og gavle på. Anvend elastikstropperne til dette (19). Anvend de korte elastikstropper (18) i mellem tag og gavle.

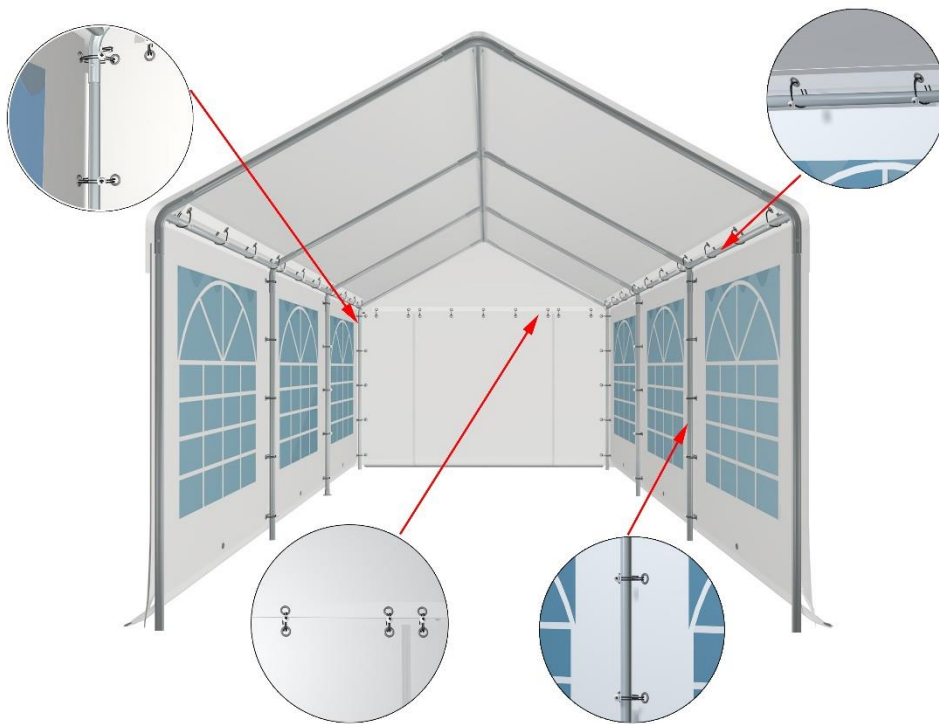
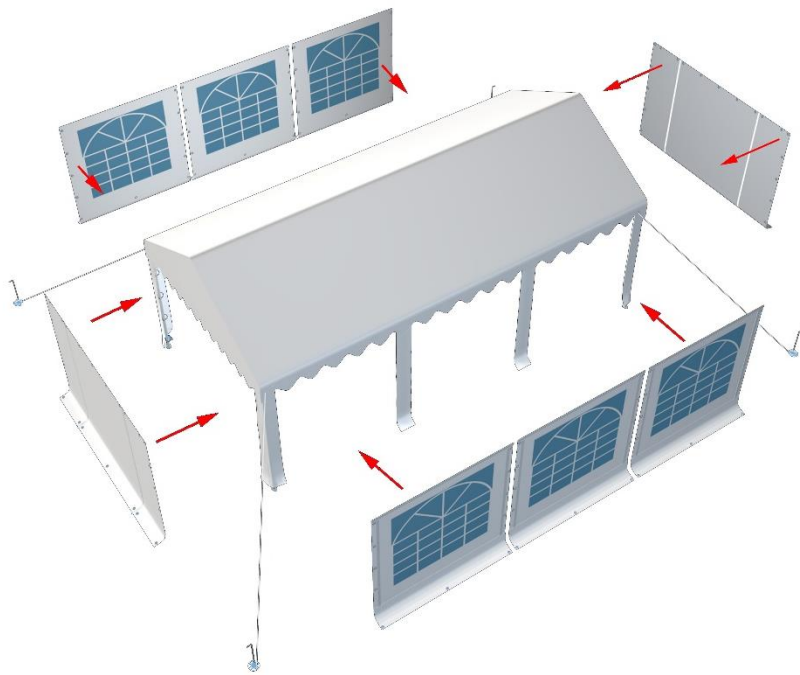

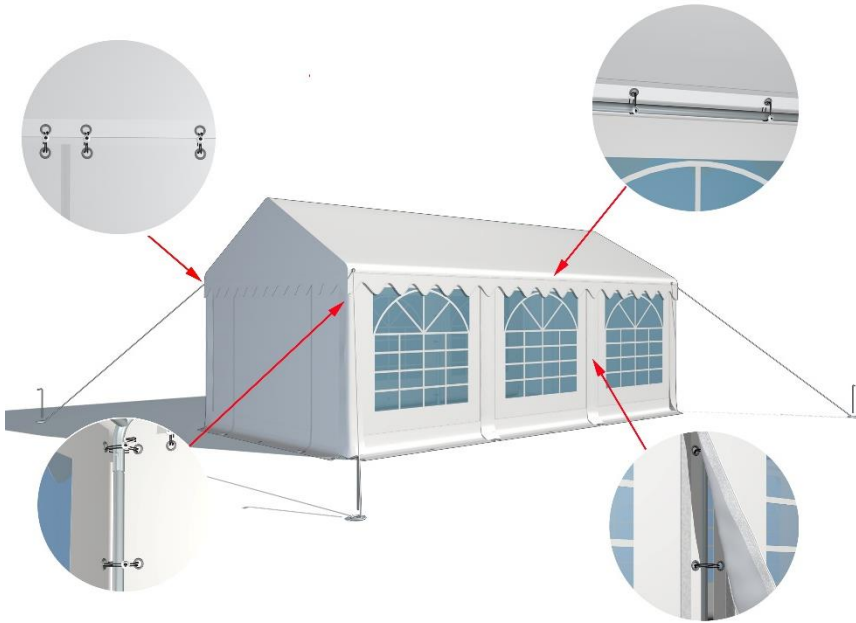

10. Monter telliner og jordankere for at gøre teltet mere stabilt. Monter linerne i stellet. Ikke i teltdugen.

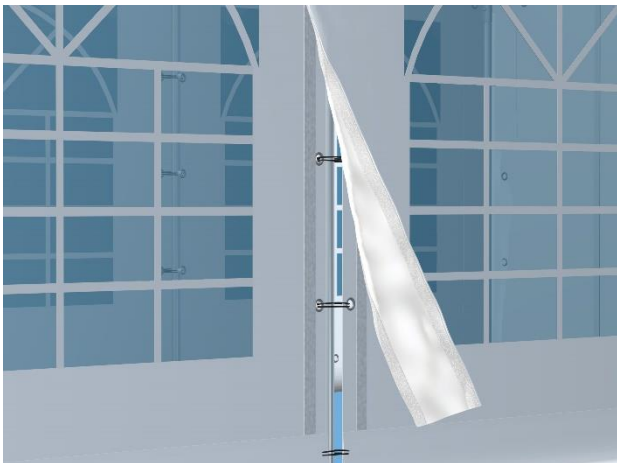

11. Monter de lange pløkke (16) i stallets fødder og anvend de korte pløkke i teltdugens øjer.

12. Sæt PVC-strimlerne der er monteret på tagdugen fast til sidevæggene og gavlene.

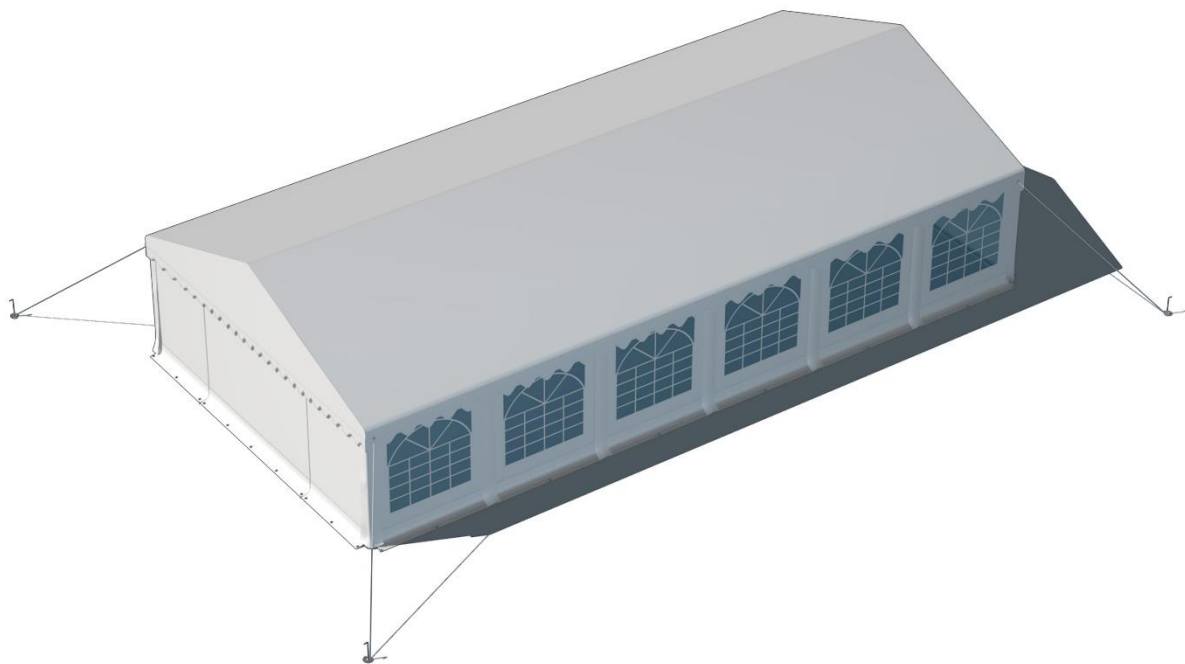

Vigtigt

1. Vær forsigtig med delene under opsætning og nedtagning. Ellers kan de blive beskadiget.
2. Teltet er ikke konstrueret til at stå opsat i længere perioder. Hvis det bliver hårdt vejr skal det nedmonteres.
3. Find en egnet plads til teltet. Undgå sprinkleranlæg og kabler i jorden.
4. Selvom dette produkt er flamme hæmmende skal man være forsigtig. Hold åben ild og andre varme kilder væk fra teltet.
5. Når teltet ikke anvendes skal det opbevares tørt.
6. Billederne i manualen er kun til illustration og kan fravige den købte model.